DARK HORSE SERIES AC EV Charger

Installation and User Manual V1.0



Objective

This manual is designed for the safe and intelligent AC EV charger developed and produced by our company

Used for GB/T, USA, and EU standards for plug-in (PHEV) and pure electric (BEV) new energy vehicles, providing comprehensive guidance for new energy vehicle users to use and maintain this charging equipment.

Manua using guide

Before using this product, please read this user manual carefully and follow the steps in the manual to operate. Any malfunctions and losses caused by non-compliance with the precautions specified in this manual are not covered by the manufacturer's warranty, and the manufacturer does not assume any related responsibility. Please do not disassemble the product. Improper disassembly may cause product damage, leakage, and ineffective waterproof function.

The content and images, logos, symbols, etc. used in the manual belong to our company. No content may be disclosed without written authorization.

The manual content will be continuously updated and revised, and users should refer to the actual product purchased.

Content

004-006 Safety instructions

007-010 Product Illustration

011-012 Product Parameters

013 Products and accessories

014 Installation preparation

015-023 Installation steps

024-026 Charging steps

027 Maintenance and Repair

028 Exception Handling

029 Inspection Checklist

Safety instructions





Safety warnings

The DARK HORSE series AC EV chargers are strictly designed and tested in accordance with relevant national and international safety standards. However, the safety of electronic devices is not only affected by the quality of the equipment itself, but also highly related to handling, installation, trial operation, operation, maintenance, dismantling, and other operations. Incorrect use or misoperation can lead to the following risks:

- Risk of electric shock, short circuit, fire, explosion, and severe burns;
- Causing harm to the life and personal safety of operators or third parties;
- Damaging the charging station, or causing other property damage or destruction at the same time.

To avoid safety accidents, the following safety precautions need to be strictly followed during installation and maintenance.

- Before installation, preparation, installation, movement, maintenance, and disassembly must be completed by professional technical personnel, and unauthorized loading and unloading is not allowed;
- Professional technical personnel are qualified and have received training and/or demonstrated skills and knowledge related to the structure and operation of charging stations;
- Have read this manual thoroughly and master the safety precautions related to operation

	<p>Warning If the charging gun or charging cable is damaged:</p> <ul style="list-style-type: none"> · Do not use, stop using immediately · Contact the charging operation staff immediately
	<p>Warning If an emergency occurs:</p> <ul style="list-style-type: none"> · Turn off the power input switch of the charging station · Contact the charging operation staff immediately · Take action based on emergency measures taken by the owner or charging operator
	<p>Warning If operating after injury, accident, typhoon, accident or disaster, please observe:</p> <ul style="list-style-type: none"> · Are there any flames or smoke inside, outside, and near the charger · Has the charger been soaked in water, and are there any other liquids or traces · Is the charger damaged due to other reasons <p>If any of the above situations occur, please stop charging immediately and contact the charging operator</p>
	<p>Warning Charging gun lock</p> <p>During the charging process, the charging gun will be locked onto the socket of the charging vehicle. It cannot be pulled out before the charging stops, and forced pulling is prohibited. Using force exceeding 1000N may damage the locking mechanism and pose a risk of arcing</p>
	<p>Caution Plug in and plug out of charging guns:</p> <ul style="list-style-type: none"> · Be careful when removing and inserting the gun, do not fall or collide · Carefully pull out the gun and return the charging cable and gun to their original position

Safety instructions

Emergency handling

Charging gun leakage, electric shock to charging operator

In the event of an emergency situation where the operator is electrocuted due to the leakage of the charging gun, other personnel on site should quickly cut off the input power switch of the charging pile to cut off the power output of the charging pile to the car, and then rescue the electrocuted person. After the danger is resolved, professional technical personnel should be notified as soon as possible to complete the maintenance of the charging gun.

Charging station internal overheating and fire

When there is a fire hazard inside the charging pile, the power supply of the charging pile should be immediately cut off, and dry powder fire extinguishers should be used for firefighting operations. After the fire is eliminated, professional technical personnel should be notified immediately for maintenance of the charging pile to prevent personnel from electric shock accidents.

The charging station is submerged or submerged in water

When the charging station is flooded or submerged, the power supply to the charging station should be immediately cut off, and our company should be notified as soon as possible. Professional technical personnel should come to the station for maintenance. Professional technical personnel should ensure that the power supply is disconnected before visiting, and users are prohibited from engaging in unauthorized power on operations.

Earthquake disaster

When an earthquake disaster occurs, the power supply of the charging pile should be cut off in a timely manner to avoid leakage accidents caused by pile damage during the earthquake. If the charging station is damaged during an earthquake, it should be promptly notified to the technical personnel for on-site treatment after the earthquake, and users are prohibited from engaging in unauthorized power on operations.

Lightning disaster

During the thunderstorm season, it is not advisable to conduct vehicle charging operations with lightning flashes and thunder. It is recommended to disconnect the power supply of the charging station. If the charging station is struck by lightning during the charging process, the power supply to the charging station should be quickly disconnected and handled by professional technical personnel. Users are prohibited from performing any operations before the arrival of professional personnel to avoid personal electric shock accidents.

The charging gun cable is pulled and broken by external force

When the charging gun is pulled by external force and causes the charging cable to break, the power supply to the charging station should be immediately cut off. At the same time, before the power supply of the charging station is disconnected, a dedicated person should be arranged to guard at a distance of 5-8 meters from the breaking point to prevent personnel from entering the radius of 5 meters around the breaking point of the charging line and causing electric shock danger. And ensure that the power supply remains disconnected until professional maintenance personnel arrive.

Safety instructions

Statement of Responsibility

Machine owner responsibility

Requirements for machine owners and on-site operators:

- Operate the charging station under the premise of fully implementing protective measures, and ensure the correct installation and regular maintenance of protective facilities
- Prepare emergency plans and instruct people on how to handle emergencies
- Prepare the installation site of the charging station according to the requirements described in this manual
- Ensure that the charging station has sufficient passage and maintenance space
- Assign a person responsible for safety operations and overall coordination

Disclaimers

The product equipment needs to be used normally within a certain range of conditions. Our company will not be responsible for any accidents or damages caused by one of the following circumstances.

- All human factors damage and use in abnormal working environments
- Failures and damages caused by not following the instructions or using the environment according to the instructions
- Damage caused by poor transportation after delivery
- Normal wear, tear, breakage, and staining
- Products that do not belong to our company (such as counterfeit goods)
- Unauthorized disassembly, repair, or modification of products without the consent of our company
- Damage caused by other uncontrollable forces (such as floods, fires, lightning strikes, typhoons, earthquakes, abnormal voltages)

Product diagram

Product Structure Diagram – Charging cable type

1.LED Light 2.LCD Screen 3.Rfid 4.Charging cable 10.LAN port (Only for OCPP version)

Product Structure Diagram – Type2 socket type

5.LCD Screen 6.Rfid 7.LED Light 8.Type2 Socket 9.LAN port (Only for OCPP version)



Product diagram

Charging cable type



Type2 socket type



Product diagram

Wall mounting plate drawing (mounting plate included in package)

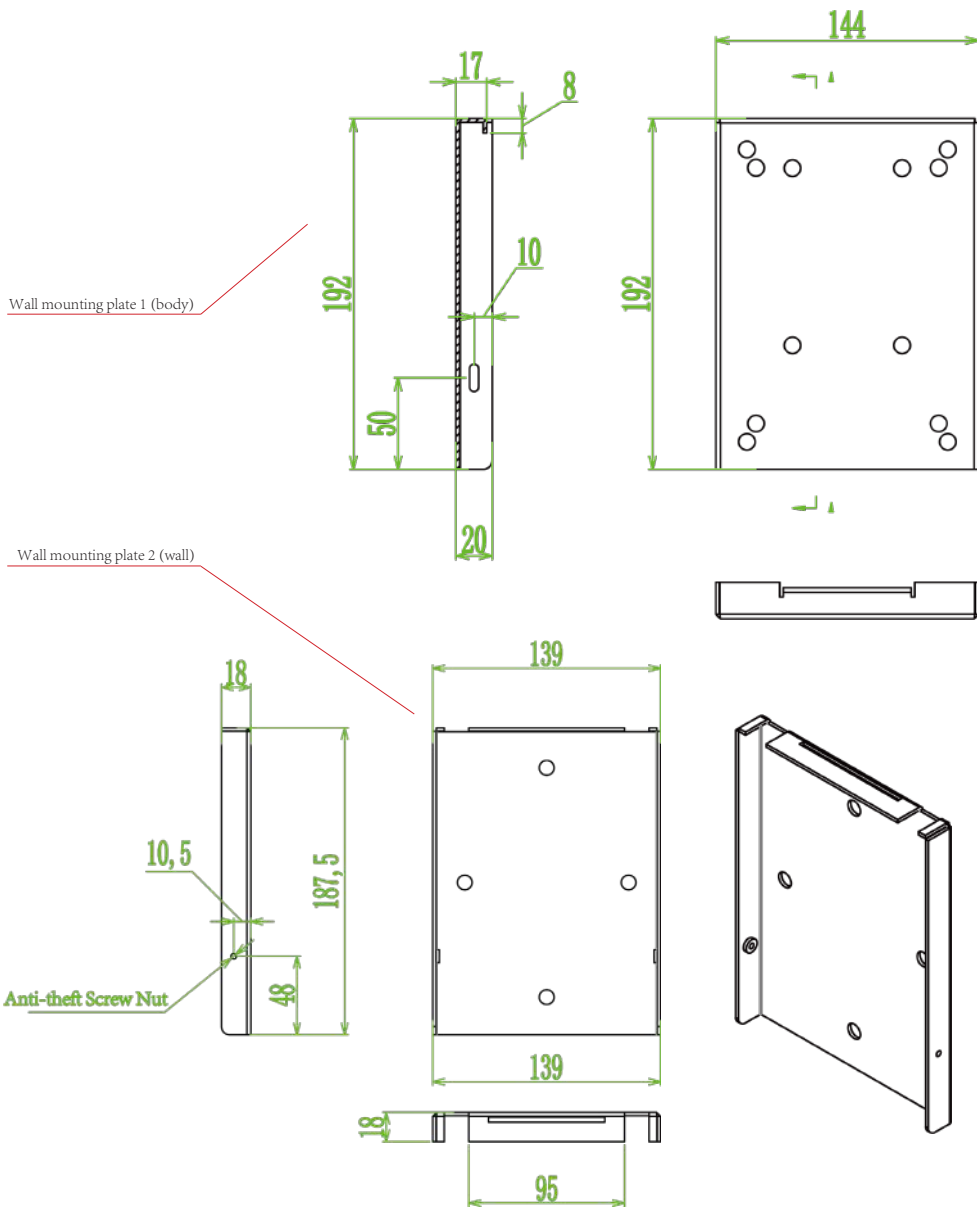

Product diagram

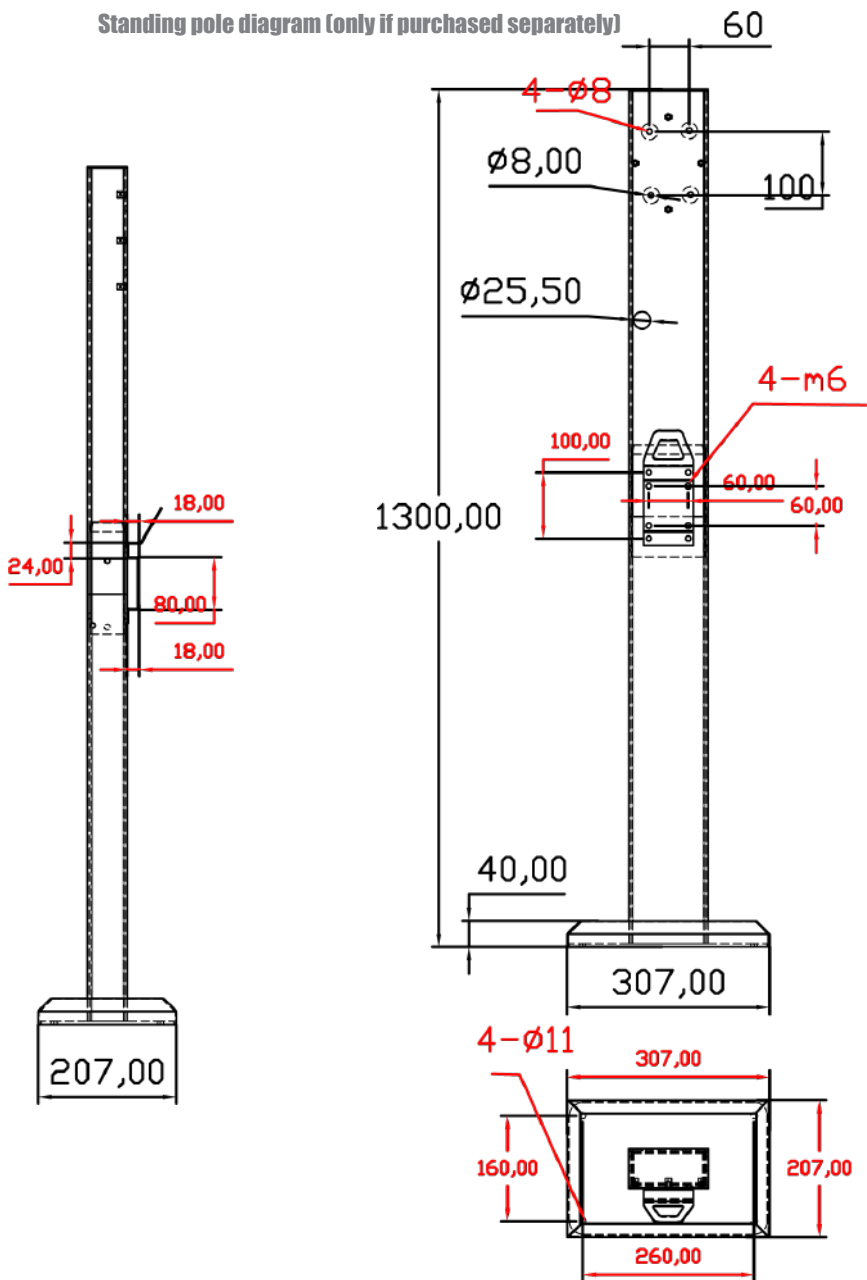

Product Parameter

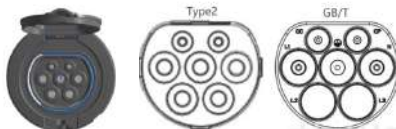

Technical parameters (GBT, Type 2)

Product Series	HOME-Basic	HOME-Upgrade	Commercial
Charging interface	IEC 61851、GB/T 20234、GB/T 18487-2015, GB/T 20234-2015		
Input Voltage Range	220VA \pm 20% (1-phase) / 380VA \pm 20%(3-phase)		
Output Voltage Range	220VA \pm 20% (1-phase) / 380VA \pm 20%(3-phase)		
Rated output current	16A/32A	16A/32A	16A/32A
Rated power	7kW/11KW/22KW	7kW/11KW/22KW	7kW/11KW/22KW
Working Frequency	45/65 Hz		
Networking method	NA	WIFI	4G/WIFI/LAN
Bluetooth	NA	Yes	Optional
Control mode	Plug and Charge	APP control / RFID card	OCPP1.6 J (QR code / RFID)
IP grade	\geq IP55		
Working Temperature	-40 C \sim +60 C		
Working Humidity	5%-95% Non-condensing		
Special Protection	UV resistance		
Working altitude	\leq 2000m		
Operating instructions	On-screen display / Buzzer		
Status indication	On-screen display /LED breathing light		
Application Scenario	Outdoor indoor parking and charging		
Weight	<7 kg		<8 kg
Dimension	238mm x 95mm x 348mm		

Product diagram

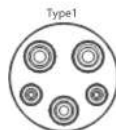

Technical parameters (Type 1)

Product Series	HOME-Basic	HOME-Upgrade	Commercial
Charging interface	SAE J1772		
Input Voltage Range	120VA \pm 20% (LEVEL 1) / 240VA \pm 20%(LEVEL 2)		
Output Voltage Range	120VA \pm 20% (LEVEL 1) / 240VA \pm 20%(LEVEL 2)		
Rated output current	16A/32A/50A	16A/32A/50A	16A/32A/50A
Rated power	7.6kW/12KW	7.6kW/12KW	7.6kW/12KW
Working Frequency	45/65 Hz		
Networking method	NA	WIFI	4G/WIFI/LAN
Bluetooth	NA	Yes	Optional
Control mode	Plug and Charge	APP control / RFID card	OCPP1.6 J (QR code / RFID)
IP grade	\geq IP55		
Working Temperature	-40 $^{\circ}$ C \sim +60 $^{\circ}$ C		
Working Humidity	5%-95% Non-condensing		
Special Protection	UV resistance		
Working altitude	\leq 2000m		
Operating instructions	On-screen display / Buzzer		
Status indication	On-screen display /LED breathing light		
Application Scenario	Outdoor indoor parking and charging		
Weight	<7 kg		<8 kg
Dimension	238mm x 95mm x 348mm		

List of products and accessories

S/N	Name	Specification / Material	Quantity	Remarks
1	Charger	EV Charger body	1	
2	Installation manual		1	
3	Anti-theft screws	M4X10 with lock core	2	For wall mounted back plate 1 and wall mounted back plate 2 mounting
4	Combination screws	M6X12	4	For wall mounted backplate 1 and EV charger body mounting
5	Wall mounting plate 1, 2	145X190X20	2	
6	Hooks	75X55X45	1	
7	Plastic Expansion Tube	6X30	3	Mounting with hooks and walls
8	Plastic Expansion Tube	10X60	4	For wall mounting plate 2 and wall mounting
9	Self-tapping screws	stainless steel M4X30	3	Mounting with hooks and walls
10	Self-tapping screws	stainless steel M6X60	4	For wall mounting plate 2 and wall mounting
11	Charging card	RFID Card	2	Only equipped with home upgrade version

standing pole(optional)

S/N	Name	Specification / Material	Quantity	Remarks
1	standing pole(upper and lower parts)	Carbon Steel	1	
2	Hook panel	Carbon Steel	1	
3	Socket part (with mounting screws)		1	Optional
4	Phillips screws	stainless steel M6X10	6	For up and down linking of columns and mounting of cable management frame
5	Expansion bolts and nuts	stainless steel M10X80	4	For mounting the post body on the ground

Preparation for Installation

Safety Precautions and Warnings

Read all instructions carefully before installation. Pay special attention to the following matters:

- As the installation process of this charging station involves electrical construction, it is necessary to be installed by professional technicians according to the instructions to ensure safety. If the charging station is damaged during installation or if the improper installation results in improper use of the charging station at a later stage, it will not be eligible for our warranty service.
- If the site to be installed is under construction, please do not install it immediately. Construction materials, dust, paint, etc. can cause damage to the charging station. It is recommended to install the EV charger after the construction is completed.
- The EV charger should use a special power supply or interface, must be well grounded, fire zero wiring is strictly prohibited to reverse. Before wiring, please switch off the power supply and take reasonable measures to prevent the power switch from closing automatically.
- When installing, please wear protective gloves to prevent the metal parts of the EV charger from hurting your hands.

Unpacking Inspection

The EV charger is shipped with a packing list. After unpacking, refer to the packing list and check whether each part of the components are complete. If there are any defects, please contact us in time.

Installation Tools

S/N	Name	Quantity	Remarks
1	Electric impact drill	1	
2	impact drill bit	1	Φ8
3	impact drill bit	1	Φ10
4	marking pen	1	
5	Level ruler	1	
6	Scale (5m)	1	
7	Electrician Gloves	1	
8	Cross Screwdriver	1	
9	T15 Anti-Theft Wrench	1	T15
10	inner hexagon spanner	1	8mm

Note, the above installation tools are recommended to be prepared by the installer in advance.

Installation Steps

Wall-mounted

Before installation, you need to prepare the corresponding fastening screws, the recommended parameters are as follows:

Screw type	Quantity to be used (pcs)	Description (use)
Self-tapping screws, stainless steel M6X60	4	Mounting wall plate 2 to the wall
Plastic Expansion Tube , 10X60	4	Mounting wall plate 2 to the wall

Step 1

Determine the mounting location using the wall mounting plate/post (recommended height is 1250 mm), and then mount the wall mounting plate to the designated location on the wall/post using an impact drill.

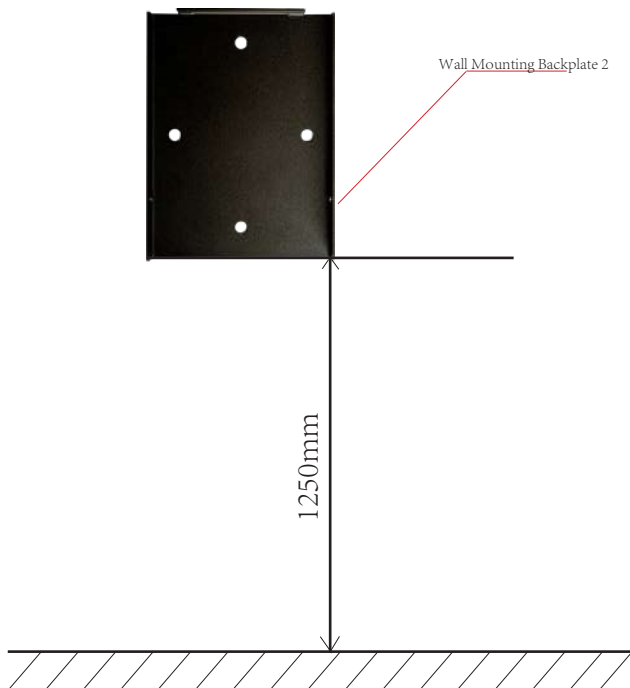

Installation Steps

Wall-mounted

Step 2

After determining the installation location, drill holes with an impact drill and use M6 expansion screws to install the wall mounting plate on the wall.

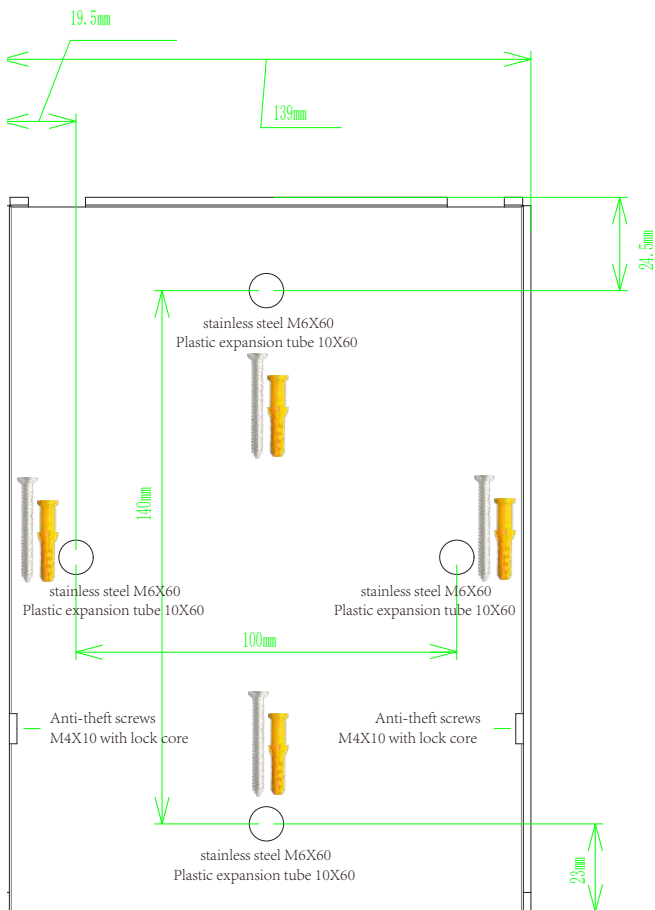

Installation Steps

Wall-mounted

Before installation, you need to prepare the corresponding fastening screws, the recommended parameters are as follows:

Screw type	Quantity to be used (pcs)	Description (use)
Combination screws, M6X12	4	Wall Mount Backplate 1 and EV charger body installation

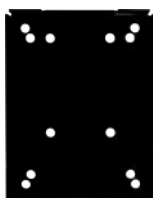

Wall Mount Backplate 1

Combination screws, M6X12



Step 3

After installing the wall mounted back plate 1, use the combination screws to attach the wall mounted back plate 1 to the back of the EV charger body.



Align the back plate 1 with the holes on the back of the EV charger.



Tighten the screws with the hexagonal socket head screw tool.



Wall mounted back plate 1 is installed.

Installation Steps

Wall-mounted

Before installation, you need to prepare the corresponding fastening screws, the recommended parameters are as follows:

Screw type	Quantity to be used (pcs)	Description (use)
Anti-theft screws, M4X10 with lock core	2	For Wall Backplate 1 and Wall Backplate 2 Installation

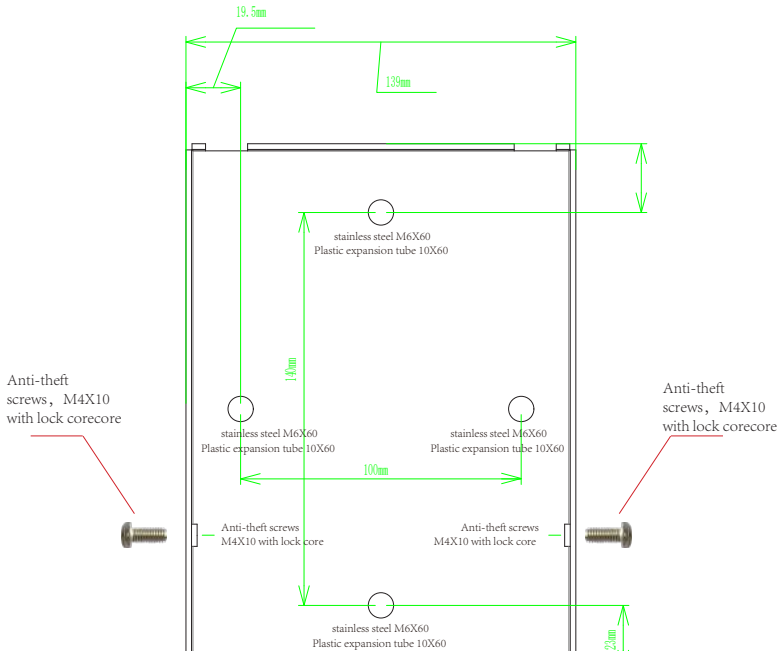

Step 4

After installing Wall Mount Backplate 2, attach Backplate 1 and Backplate 2 together. Screw on the anti-theft screws.



Combining Backplane 1,2



Backplane 1 slides down and snaps into place.



Observe the anti-theft screw holes



Punch in the anti-theft screws on both sides

Installation Steps

Wall-mounted

Step 5

Wiring needs to meet the following requirements:

1. The charging station should have an independent power distribution circuit and should not be shared with other electrical products.
2. 2.5mm² cable is required at the input end of the 3.5KW/11KW station, 6mm² cable is required at the input end of the 7KW/22KW station, and crimp terminals are required at the input end.
3. In order to prevent electric shock, make sure the input ground is firmly grounded, install according to the installation instructions, and prohibit the use of two-pronged or three-pronged plugs at the front end of the charging station, for which the Division will not be responsible for any consequences.

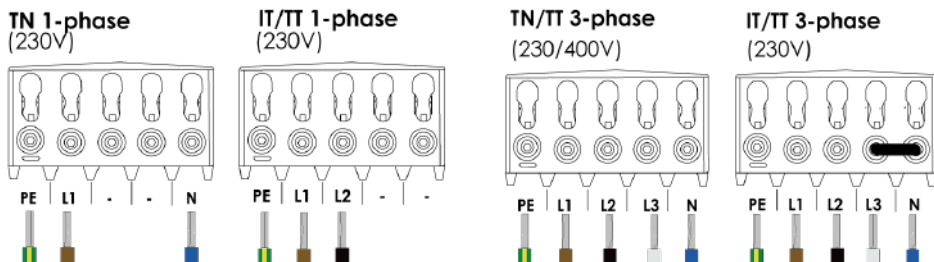

Note that in a three-phase 230V power supply environment without N wire, please short the blue N wire and the gray L3 wire
L1 brown, L2 black, L3 gray, N blue, PE yellow-green two-color

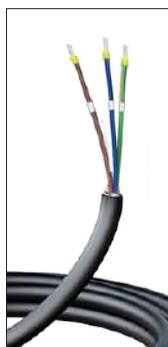

1-phase



3-phase

We will leave a 1m length of wiring already connected, please follow the above guide to connect the wires without opening the cover.

Installation Steps

Wall-mounted

Before installation, you need to prepare the corresponding fastening screws, the recommended parameters are as follows:

Screw type	Quantity to be used (pcs)	Description (use)
Self-tapping screws, stainless steel M4X30	3	Installation of the hook on the wall
Plastic Expansion Tube , 6X30	3	Installation of the hook on the wall



Step 6

Mount the hook on the right wall of the EV charger.

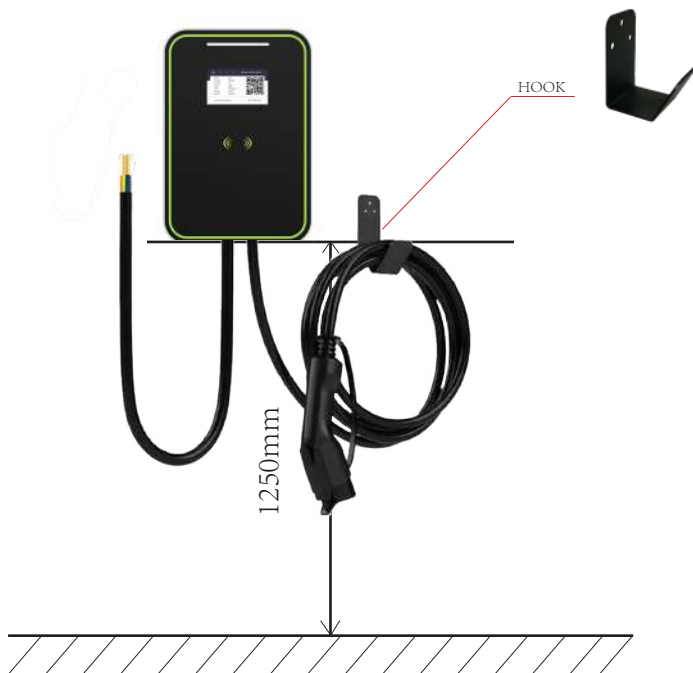

Installation Steps

Wall-mounted

Step 7

Finally, wrap the charging cable moderately around the hook and power up. The indicator light is on after powering up, and the installation is completed. If there is any abnormal state, please deal with it in time according to the abnormal phenomenon.

There is a layer of PE protective film on the front panel of the EV charger, you can tear off the PE protective film when the whole project is completely finished and you are about to start using the EV charger.

Installation Steps

Floor-mounted type

Before installation, you need to prepare the corresponding fastening screws, the recommended parameters are as follows:

Screw type	Quantity to be used (pcs)	Description (use)
Self-tapping screws, stainless steel M10X80	4	For installation on pole on the ground
Combination screws, M6X12	4	Installation of ev charger body and pole
Phillips screws, stainless steel M6X10	6	Upper and lower connection of pole and installation of hook panel



Installation Steps

Floor-mounted type

Note: The wiring part is the same as the wall-mounted installation method, please install the specified operation.

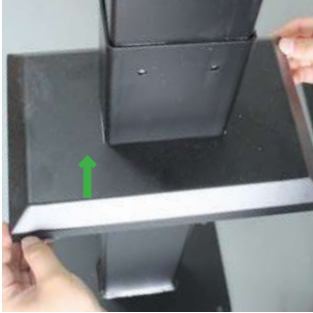

1. Lift the cover



2. Drive in the expansion screws



3. Connect the column bodies 1 and 2.



4. Install the cable management bracket



5. Install two side fixing screws



6. Installation of the hanger (optional)



7. Connect the inlet cable of the EV charger



8. Align the holes on the back of the EV charger



9. Tighten the four screws to complete the installation.

Charging Steps

by RFID Card

Step 1 Insert the gun

Remove the charging gun from the EV charger and connect it to the charging port of the car. When the connection is successful, the light bar is always on in yellow.

The screen displays: Available → Preparing.

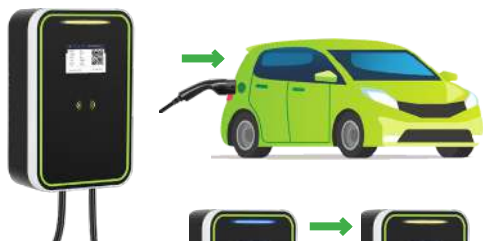

Step 3 Charging

After entering the charging state, the light bar is in green breathing state.

Screen display: Preparing → Charging.



Step 2 Swipe

Bring the RFID card close to the swipe area, when the card is swiped successfully, the green light will be breathing. Wait for the communication of vehicle end to complete and start charging. Buzzer: one drop



Step 4 End charging

When the charging is full or the swipe card is finished (the buzzer beeps once when the swipe card is finished), the green light is always on. Pull out the charging gun from the vehicle end and hang it back to the EV charger hook.

Screen display: Finishing → Available

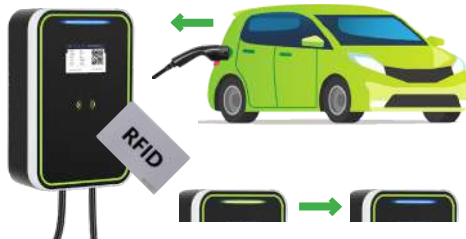

Charging Steps

by APP control

Step 1 Plug in the gun

Remove the charging gun from the EV charger and connect it to the charging port of the car. When the connection is successful, the light bar is always on in yellow.

The screen displays: Available → Preparing.

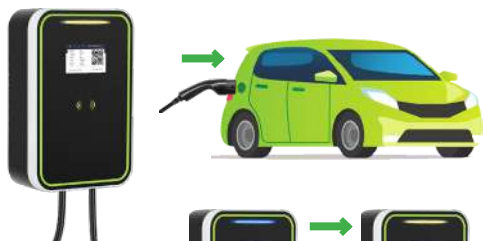

Step 3 Charging

After entering the charging state, the light bar is green and breathing.

The screen displays: Preparing → Charging.



Step 2 APP Control

After APP remote control turns on the charging, wait for the car communication to complete and start charging.



Step 4 End Charging

When the charging is full or APP control ends, the green light is always on. Pull out the charging gun from the vehicle end and hang it back to the EV charger hook.

The screen displays: Finishing → Available



Charging Steps

by Plug and charge

Step 1 Plug in the gun

Remove the charging gun from the EV charger and connect it to the charging port of the car. When the connection is successful, the light bar is always on in yellow.

The screen displays: Available → Preparing.

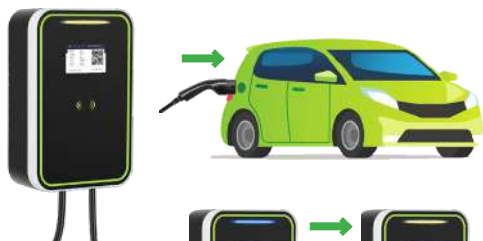

Step 3 End charging

When the charging is full, the green light is always on. Pull out the charging gun from the vehicle end and hang it back to the EV charger hook.

The screen displays: Finishing → Available



Step 2 Charging

After entering the charging state, the light bar is green and breathing. The screen displays: Preparing → Charging.



Maintenance

- Always ensure that the charging gun is inserted back into the charging gun holder of the EV charger after charging.
- Check the EV charger and the charging cable regularly for damage. If damage is found, please contact us.
- This EV charger does not contain user-serviceable components. If the unit is not functioning properly, contact us.
- Wipe the exterior of the EV charger, the charging cable, and the EV charger end of the charging cable with a clean, dry cloth to remove dirt and dust build-up.

During the warranty period, the warranty and related rights will be forfeited if any of the following conditions apply

- Damage to the charging equipment or associated equipment caused by changes in the power supply environment.
- Damage caused by improper transport by the user after sale.
- Damage caused by improper use or man-made reasons.
- The user disassembles, repairs or modifies the product without our consent.

Abnormal Handling

S/N	Abnormal phenomenon	Possible Causes	Solution
1	LED light does not light up	power wire incorrect	Check the power line again by the installer
		LED light not connected	Installer to recheck light wiring
		Air switch tripped	Reset the switch
2	Red light is always on	Fault occurs	Check screen for faults, contact us
3	No response to card swipe	RFID card not close to swipe position	Remove the card, and then close to the swipe area, do not move the card up and down, left and right
		Magnetic card not working or damaged	Please contact the customer service centre to replace the card (man-made damages need to be paid to replace the card)
4	Charging failure	Charging gun is not plugged	Re-plug and reconnect the charging gun to ensure that the gun is connected in place; check whether there is any error light in the EV charger ; check whether the buttons on the top of the charging gun are in a natural state; try to restart the EV charger by disconnecting the power.
		Problems with the vehicle itself	Go to Car shop to investigate the vehicle's own problem.

End-of-life Disposal

When a product reaches the end of its useful life, or is damaged beyond use for any reason and needs to be scrapped, the product must be sent to a qualified

Inspection List

S/N	Inspection items	Acceptance criteria	results
1	Interior appearance	The wiring is correct, the screws are fastened.	OK
2	Overall appearance	Visually free of appearance defects, fully identified	OK
3	Electrical inspection	General on check, short-circuit check, ground check	OK
4	Safety Check	Insulation resistance and dielectric strength	OK
5	Function check	Power-on light with on-board charging	OK
6	Charging connector	Meet interoperability requirements	OK
7	Accessories package	Complete materials, no omissions	OK
8	Packing inspection	Complete material, no visual defects	OK